

EASYZONE

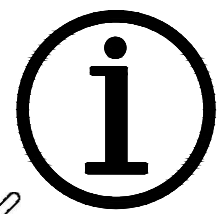

AZX6GTC[XXX]/AZX6QADAPT3[XXX]

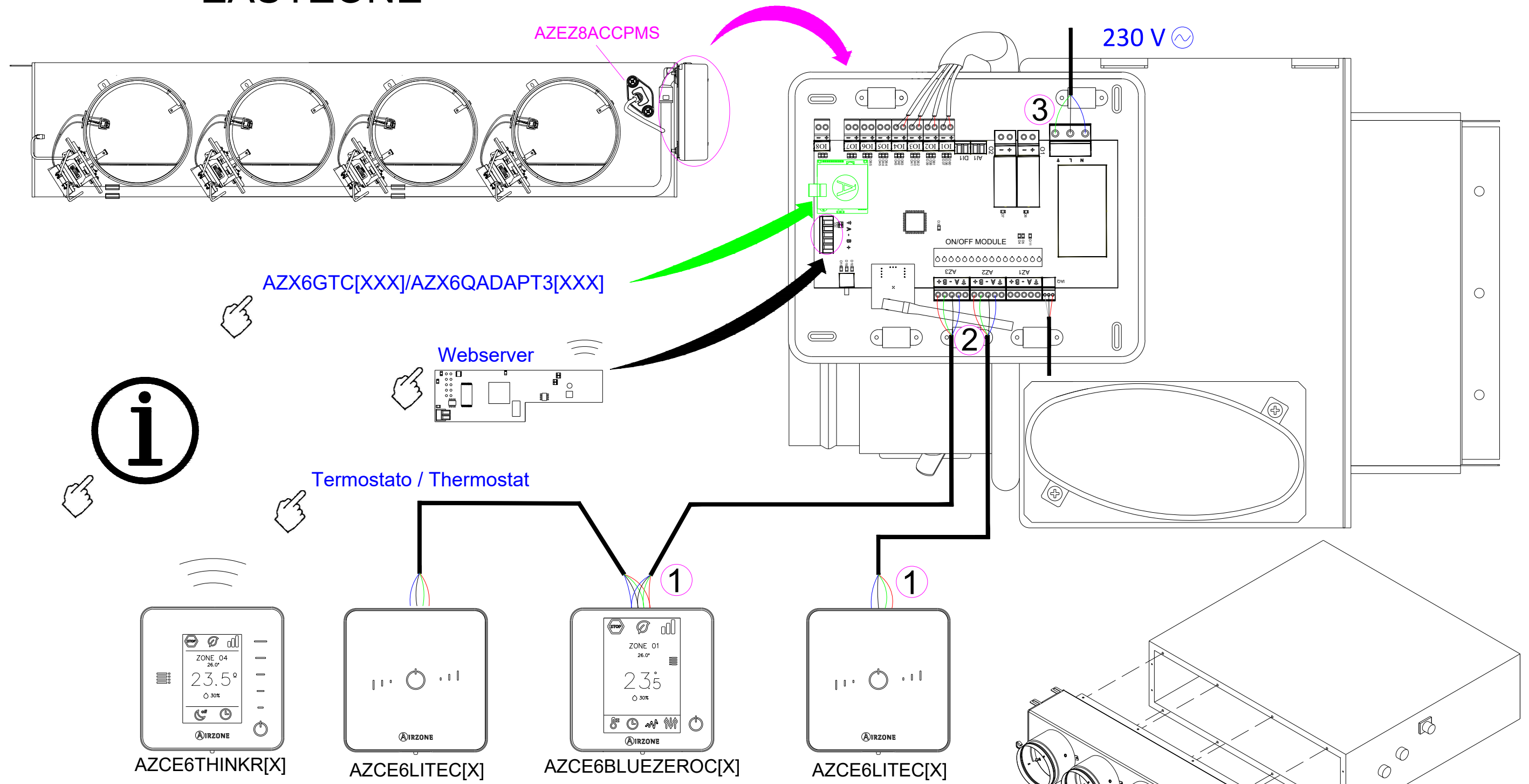
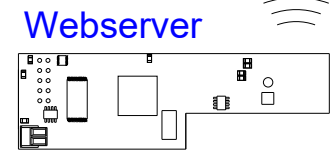

Termostato / Thermostat

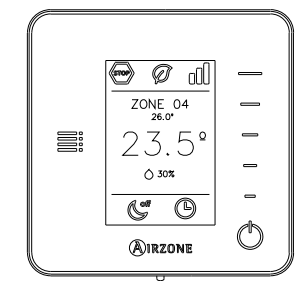

AZCE6THINKR[X]

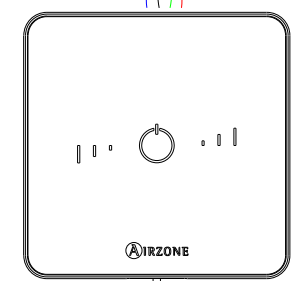

AZCE6LITEC[X]

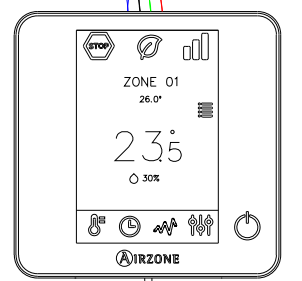

AZCE6BLUEZEROC[X]

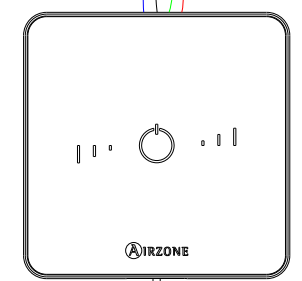

AZCE6LITEC[X]

- A Azul | Blue | Azul | Bleu | Blu
- Negro | Black | Negro | Noir | Nero
- B Verde | Green | Verde | Vert | Verde
- + Rojo | Red | Vermelho | Rouge | Rosso

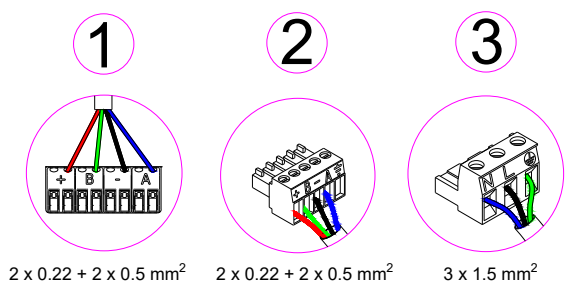

- N Neutro | Neutral | Neutro | Neutre | Neutro
- L Fase | Phase | Fase | Phase | Fase
- ⊕ Tierra | Ground | Terra | Terre | Terra

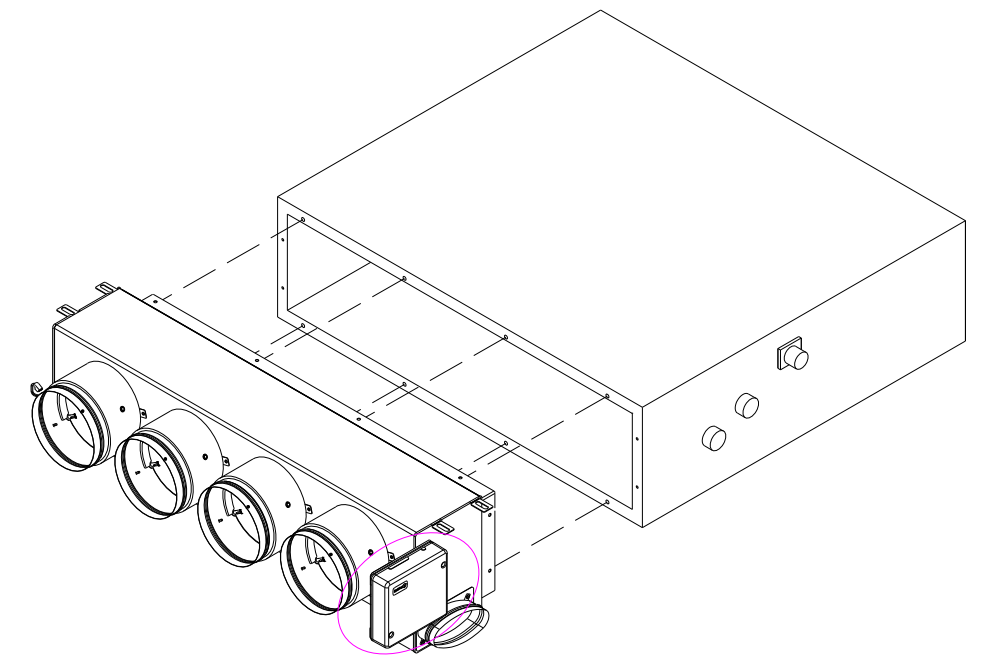

EQUIPO INVERTER DE CONDUCTOS ZONIFICADO PARA CONDUCTO FLEXIBLE HASTA 8 ZONAS

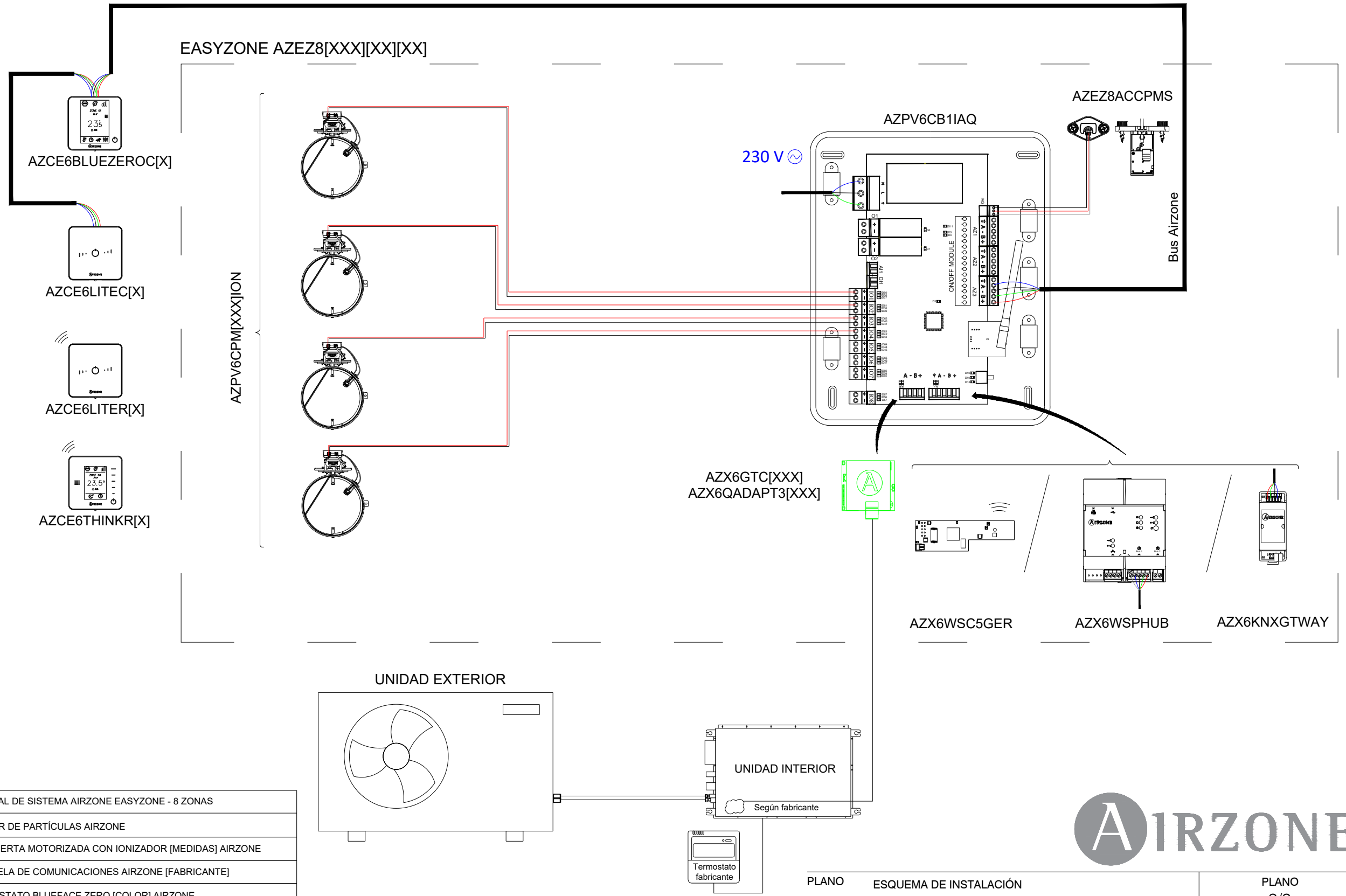

AZE8[xxx][xx][xx] [Gama][Talla][No. de puertas]	CENTRAL DE SISTEMA AIRZONE EASYZONE - 8 ZONAS
	SENSOR DE PARTÍCULAS AIRZONE
	COMPUERTA MOTORIZADA CON IONIZADOR [MEDIDAS] AIRZONE
	PASARELA DE COMUNICACIONES AIRZONE [FABRICANTE]
AZCE6BLUEZERO[X]	TERMOSTATO BLUEFACE ZERO [COLOR] AIRZONE
AZCE6THINKR[X]	TERMOSTATO RADIO THINK [COLOR] AIRZONE
AZCE6LITER[X]	TERMOSTATO RADIO LITE [COLOR] AIRZONE
AZX6WSPHUB	WEBSERVER HUB AIRZONE CLOUD DUAL
AZX6KNXGTWAY	PASARELA DE INTEGRACIÓN KNX-AIRZONE



UNITÉ GAINABLE GAINES FLEXIBLES AVEC PLENUM MOTORISÉ JUSQU'À 8 ZONES (EASYZONE)

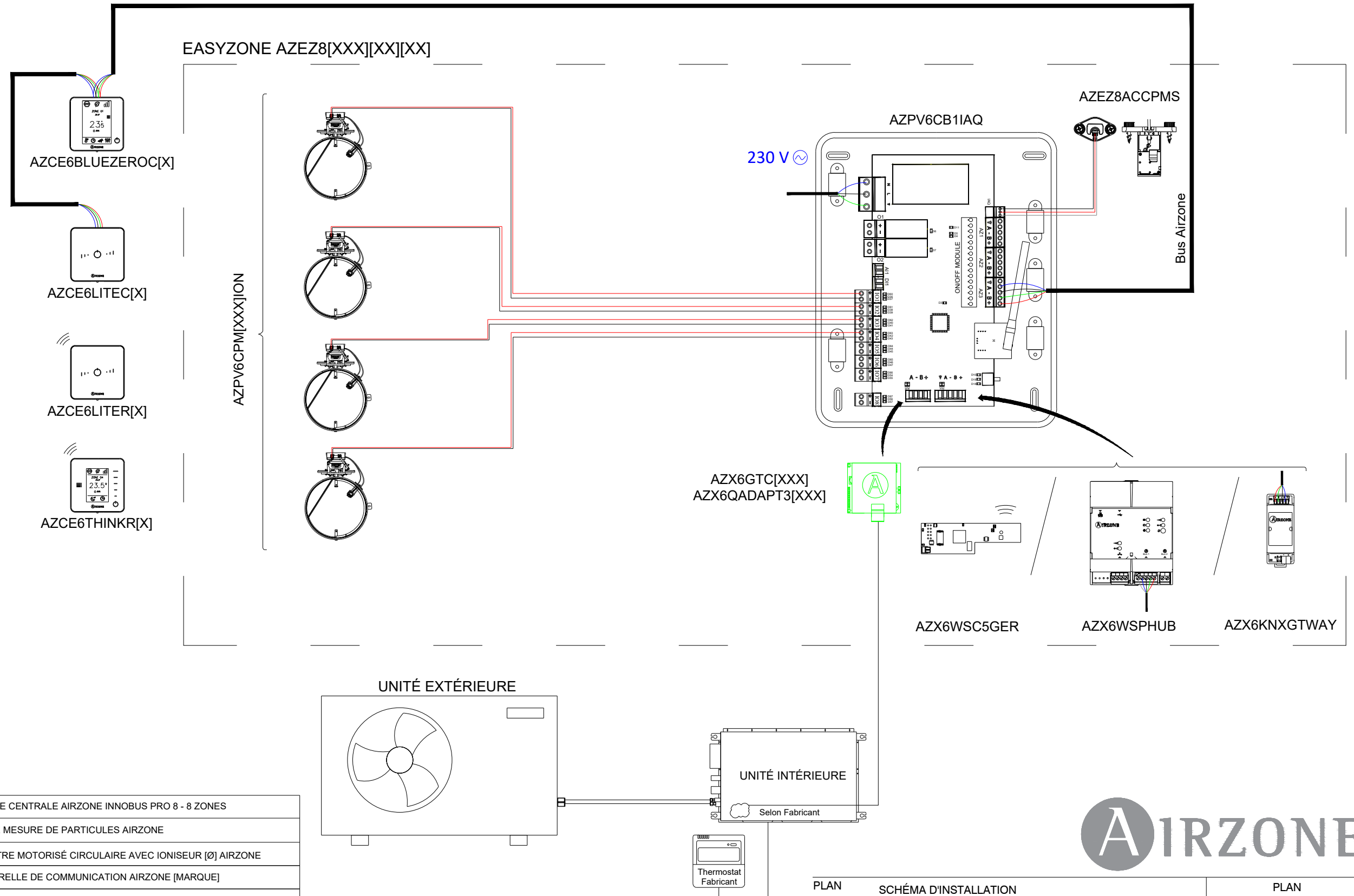

AZE8[xxx][xx][xx] [Gamme][Talle][Nb. de registres motorisés]	PLATINE CENTRALE AIRZONE INNOBUS PRO 8 - 8 ZONES
	SONDE MESURE DE PARTICULES AIRZONE
	REGISTRE MOTORISÉ CIRCULAIRE AVEC IONISEUR [Ø] AIRZONE
	PASSERELLE DE COMMUNICATION AIRZONE [MARQUE]
AZCE6BLUEZEROC[X]	THERMOSTAT BLUEFACE ZERO FILAIRE [COULEUR] AIRZONE
AZCE6THINKR[X]	THERMOSTAT THINK RADIO [COULEUR] AIRZONE
AZCE6LITER[X]	THERMOSTAT LITE RADIO [COULEUR] AIRZONE
AZX6WSPHUB	WEBSERVER HUB AIRZONE CLOUD DUAL
AZX6KNXGTWAY	PASSERELLE D'INTÉGRATION KNX-AIRZONE



ZONED INVERTER UNIT FOR FLEXIBLE DUCT-UP TO 8 ZONES

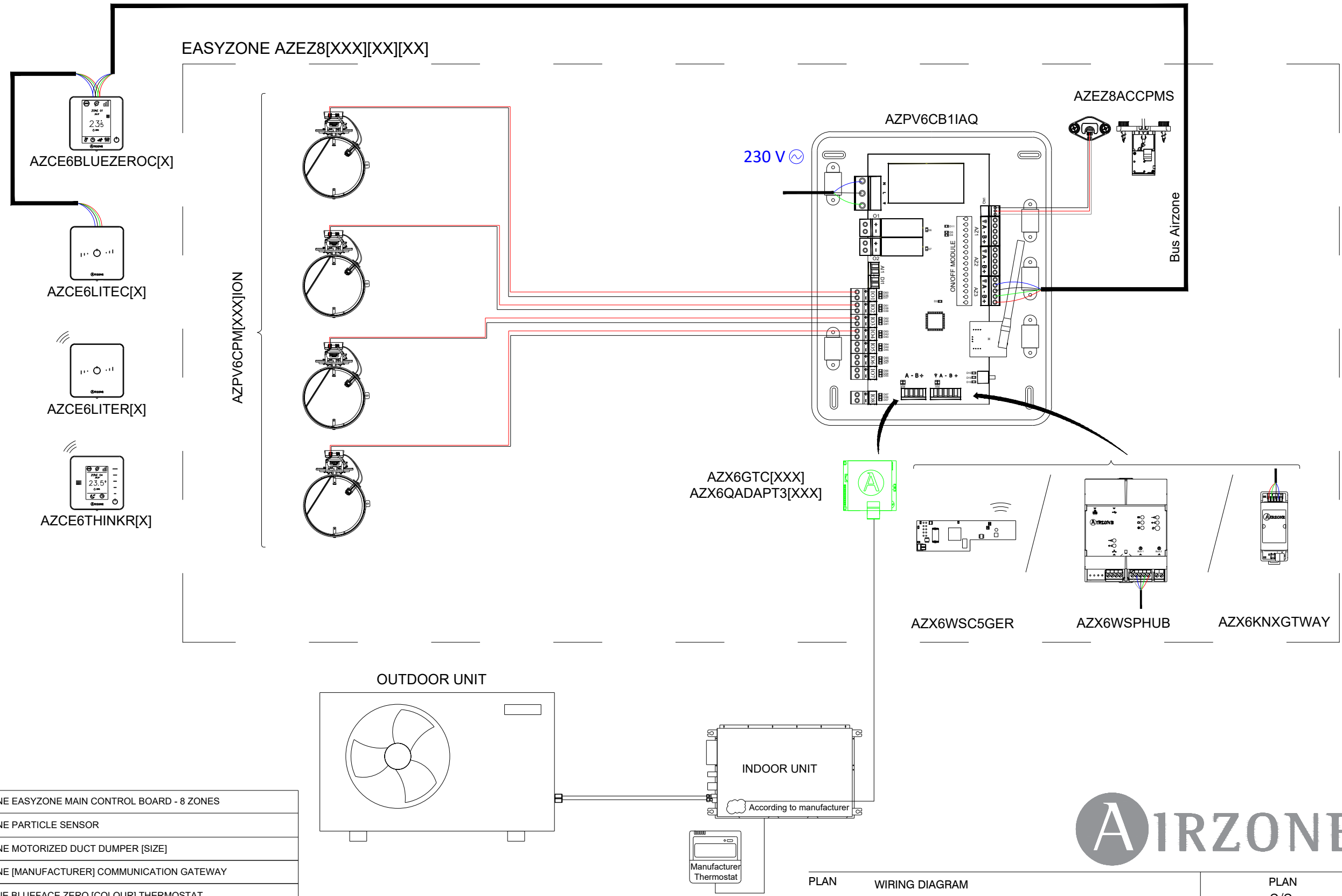

AZEZ8[XXX][XX][XX] [Range][Size][Number of dumper]	AIRZONE EASYZONE MAIN CONTROL BOARD - 8 ZONES
	AIRZONE PARTICLE SENSOR
	AIRZONE MOTORIZED DUCT DUMPER [SIZE]
	AIRZONE [MANUFACTURER] COMMUNICATION GATEWAY
AZCE6BLUEZEROC[X]	AIRZONE BLUEFACE ZERO [COLOUR] THERMOSTAT
AZCE6THINKR[X]	AIRZONE THINK [COLOUR] WIRELESS THERMOSTAT
AZCE6LITER[X]	AIRZONE LITE [COLOUR] WIRELESS THERMOSTAT
AZX6WSPHUB	AIRZONE WEBSERVER HUB CLOUD DUAL
AZX6KNXGTWAY	KNX AIRZONE INTEGRATION GATEWAY



UNITÀ CANALIZZATA AD ESPANSIONE DIRETTA CON PLENUM MOTORIZZATO FINO A 8 ZONE

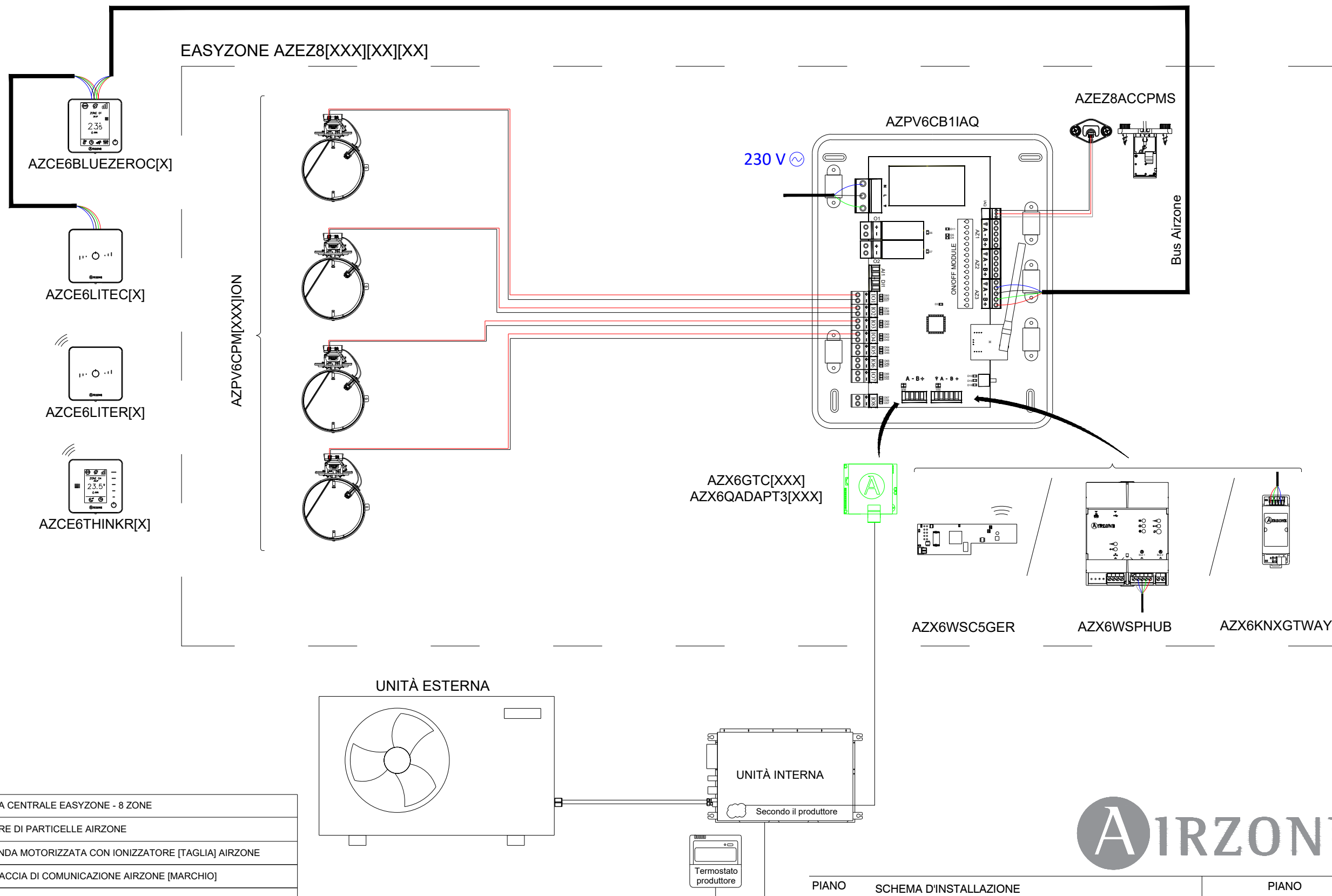

AZE8[xxx][xx][xx] [Gamma][Taglia][No. di serrande]	SCHEDA CENTRALE EASYZONE - 8 ZONE
	SENSORE DI PARTICELLE AIRZONE
	SERRANDA MOTORIZZATA CON IONIZZATORE [TAGLIA] AIRZONE
	INTERFACCIA DI COMUNICAZIONE AIRZONE [MARCHIO]
AZCE6BLUEZEROC[X]	TERMOSTATO BLUEFACE ZERO [COLORE] AIRZONE
AZCE6THINKR[X]	TERMOSTATO THINK RADIO [COLORE] AIRZONE
AZCE6LITER[X]	TERMOSTATO LITE RADIO [COLORE] AIRZONE
AZX6WSPHUB	WEBSERVER HUB AIRZONE CLOUD DUAL
AZX6KNXGTWAY	INTERFACCIA D'INTEGRAZIONE KNX-AIRZONE



PIANO SCHEMA D'INSTALLAZIONE PIANO 2/2

DISEGNATO DA : UFFICIO PROGETTI ALTRA CORPORACIÓN

DATA : 2021
 TITOLO : CANALIZZATA AD ESPANSIONE DIRETTA CON PLENUM MOTORIZZATO FINO A 8 ZONE
 CONTATTO: progetti@airzoneitalia.it Telefono: 02568 14756 www.airzoneitalia.it

UNIDADE INVERTER DE CONDUTAS ZONIFICADA PARA CONDOTA FLEXÍVEL ATÉ 8 ZONAS

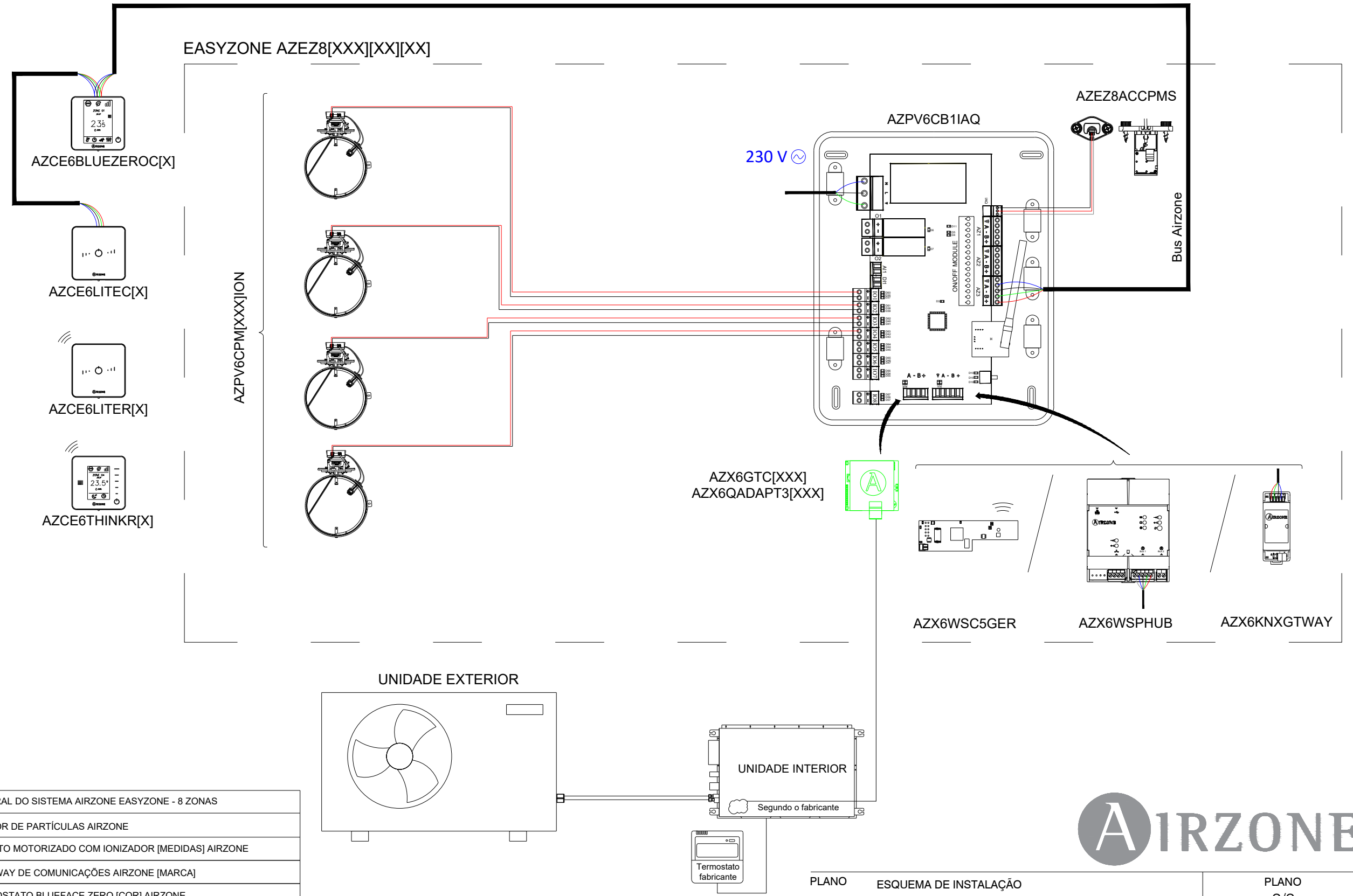

AZEZ8[xxx][xx][xx] [Gama][Tamanho][No. de registros]	CENTRAL DO SISTEMA AIRZONE EASYZONE - 8 ZONAS
	SENSOR DE PARTÍCULAS AIRZONE
	REGISTO MOTORIZADO COM IONIZADOR [MEDIDAS] AIRZONE
	GATEWAY DE COMUNICAÇÕES AIRZONE [MARCA]
AZCE6BLUEZEROC[X]	TERMOSTATO BLUEFACE ZERO [COR] AIRZONE
AZCE6THINKR[X]	TERMOSTATO RADIO THINK [COR] AIRZONE
AZCE6LITER[X]	TERMOSTATO RADIO LITE [COR] AIRZONE
AZX6WSPHUB	WEBSERVER HUB AIRZONE CLOUD DUAL
AZX6KNXGTWAY	GATEWAY DE INTEGRAÇÃO KNX-AIRZONE

